

RACK – FLOOR STANDING

FLOOR STANDING RACK

Description

The ORCA Networking SERVER cabinets are designed and manufactured in compliance with quality and safety standards, optimal solutions for the management and organization of structure cabling. Orca system offers a range of wall racks with relative accessories. Rack cabinets are distinguished by their exceptional robustness, which, combined with affordability and simplicity of assembly/disassembly, place them at the top of their category.



General Feature

Feature:

- 19" Compatibility, Brushed and pre-cut Cable Entries
- Material: 12/10 Steel - Finish Surface Powder Coating, Color RAL9005 (Black)
- IP20 protection degree in according to EN 60529.
- Passive ventilation slots and perforated panels for the recirculation of hot air
- Front glass single door - Reversible, with quick release hinges system.
- With foldaway handle, 3 point locking system, 2 key supplied. Opening 110°
- Blind side and rear panels removable with quick release system and 1/4 turn lock;
- 33, 42, 47U with removable panel divided into two parts.
- Front and rear 19 " in 20/10 galvanized steel side uprights adjustable in depth;
- Roof with predisposition for mounting 2-4 or more fans ventilation unit, pre-punched space for cable inlet
- Pre-punched and brushes space for cable inlet on bottom.
- Levelling feet and wheels;
- Standard ground kit;
- Static Load Capacity: 800kg
- Optional - Finishing plinth H100mm
- On 800 version, 2 front vertical cable management with doors.

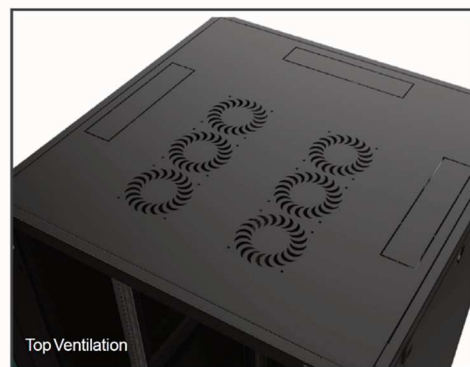

Specifications subject to change without prior notice - For more details please visit www.orca.it

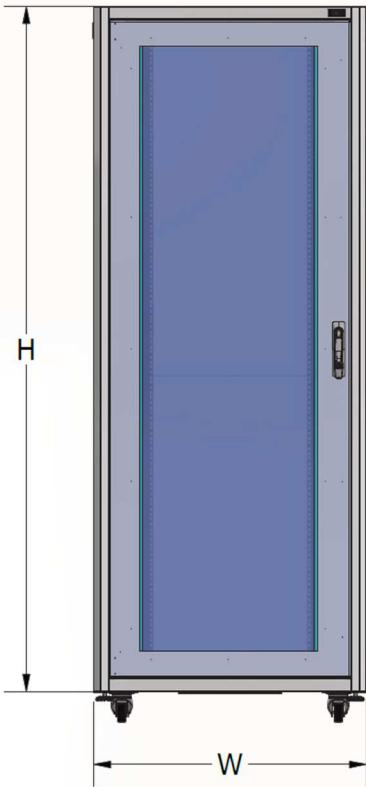

Front View

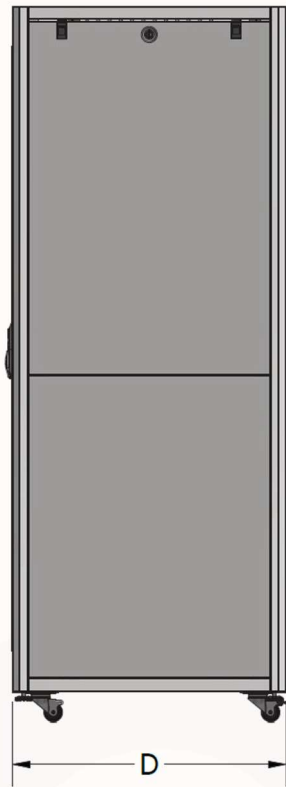

Side View

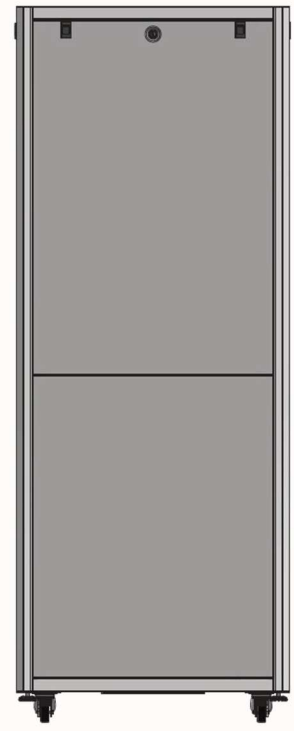

Rear View

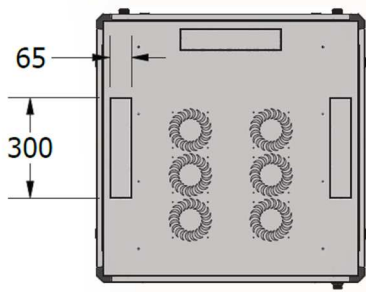

Top View

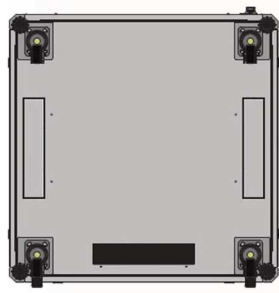

Bottom View

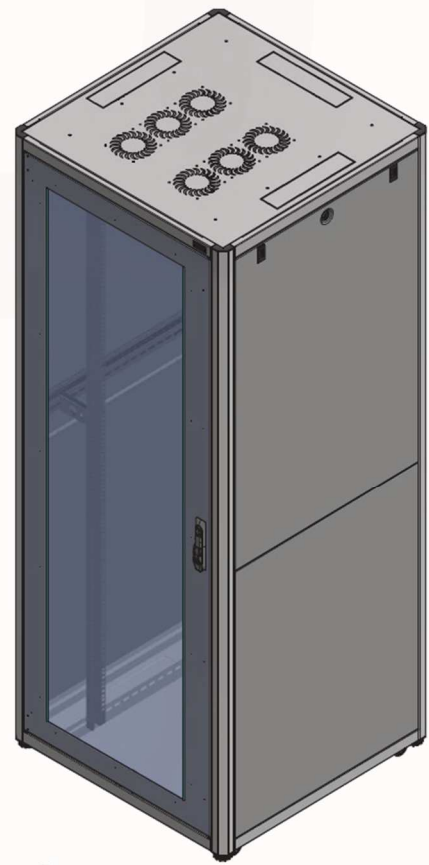

Front Isometric View

Specifications subject to change without prior notice - For more details please visit www.orca.it

agg. draft/2022

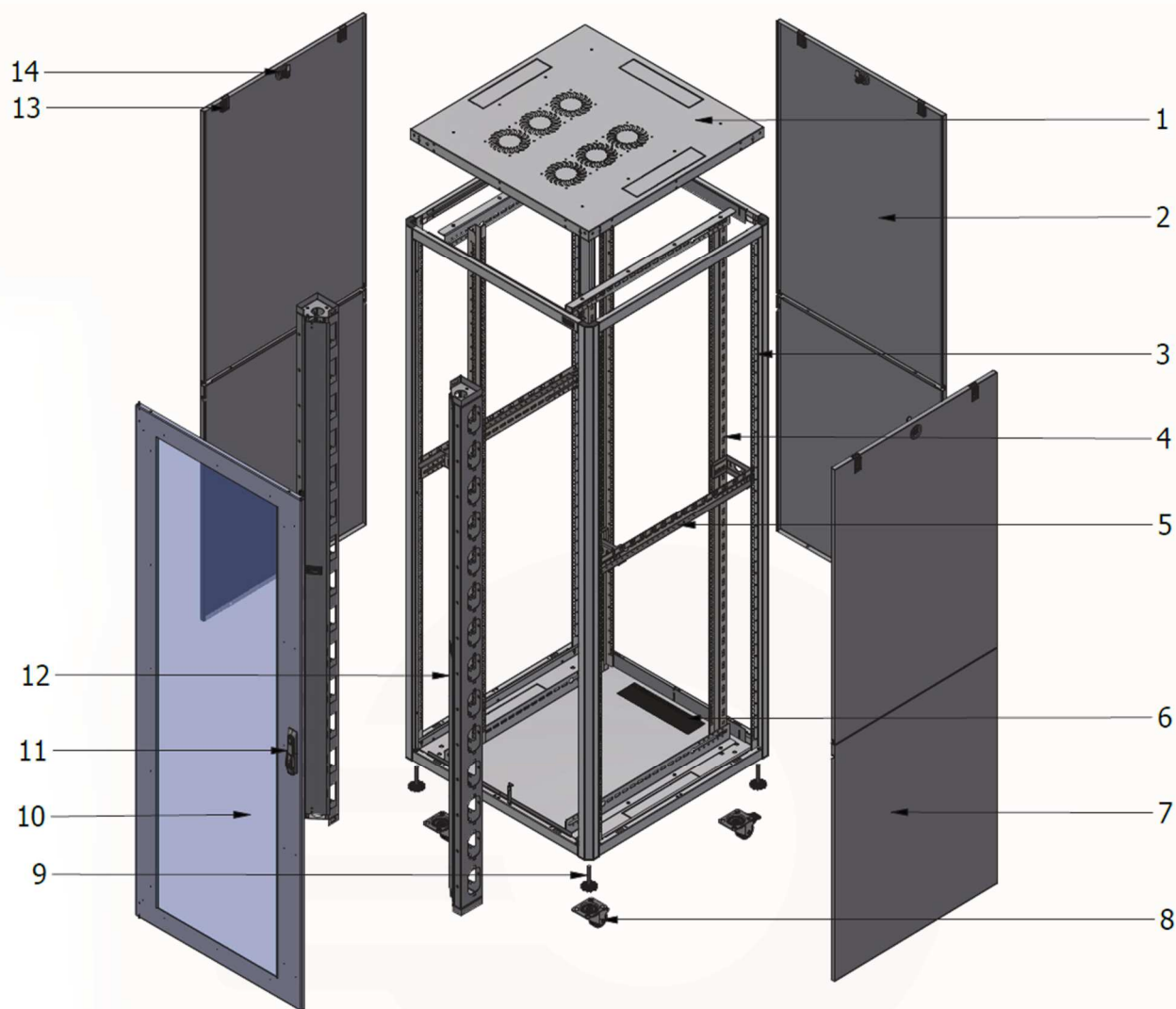

Exploded diagram

COMPONENT LIST

1	Top Chassis	8	Caster
2	Upper Side Panel	9	Pinion Feet
3	Cabinet Main Frame	10	Glass Front Door
4	19" Device Mounting Rail	11	Front Door Locking Mechanism
5	Horizontal Support Bar	12	Vertical Cable Organiser
6	Brushed Cable Entry	13	Side Panel Plastic Sliding Lock
7	Lower Side Panel	14	Side Panel Barrel Lock

Specifications subject to change without prior notice - For more details please visit www.orca.it

U	W(mm) Overall/Useful	D(mm) Overall/Useful	H(mm) Overall/Useful
600x600			
20	600 / 515	600 / 550	1027 / 902
24	600 / 515	600 / 550	1205 / 1080
27	600 / 515	600 / 550	1340 / 1215
33	600 / 515	600 / 550	1605 / 1480
42	600 / 515	600 / 550	2005 / 1880
600x800			
27	600 / 515	800 / 750	1340 / 1215
33	600 / 515	800 / 750	1605 / 1480
42	600 / 515	800 / 750	2005 / 1880
47	600 / 515	800 / 750	2228 / 2103
800x800			
33	800 / 715	800 / 750	1605 / 1480
42	800 / 715	800 / 750	2005 / 1880
47	800 / 715	800 / 750	2228 / 2103

Ordering Information code:**600 * 600**

OC-RKF-662000-00M	ORCA - Floor Standing Rack, 600x600x20U, front glass single door, blind rear and side panels, load capacity 800 kg Black
OC-RKF-662400-00M	ORCA - Floor Standing Rack, 600x600x24U, front glass single door, blind rear and side panels, load capacity 800 kg Black
OC-RKF-662700-00M	ORCA - Floor Standing Rack, 600x600x27U, front glass single door, blind rear and side panels, load capacity 800 kg Black
OC-RKF-663300-00M	ORCA - Floor Standing Rack, 600x600x33U, front glass single door, blind rear and side panels in 2 sections, load capacity 800 kg Black
OC-RKF-664200-00M	ORCA - Floor Standing Rack, 600x600x42U, front glass single door, blind rear and side panels in 2 sections, load capacity 800 kg Black

600 * 800

OC-RKF-682700-00M	ORCA - Floor Standing Rack, 600x800x27U, front glass single door, blind rear and side panels, load capacity 800 kg Black
OC-RKF-683300-00M	ORCA - Floor Standing Rack, 600x800x33U, front glass single door, blind rear and side panels in 2 sections, load capacity 800 kg Black
OC-RKF-684200-00M	ORCA - Floor Standing Rack, 600x800x42U, front glass single door, blind rear and side panels in 2 sections, load capacity 800 kg Black
OC-RKF-684700-00M	ORCA - Floor Standing Rack, 600x800x47U, front glass single door, blind rear and side panels in 2 sections, load capacity 800 kg Black

800 * 800

OC-RKF-883300-00M	ORCA - Floor Standing Rack, 800x800x33U, front glass single door, blind rear and side panels in 2 sections, load capacity 800 kg Black
OC-RKF-884200-00M	ORCA - Floor Standing Rack, 800x800x42U, front glass single door, blind rear and side panels in 2 sections, load capacity 800 kg Black
OC-RKF-884700-00M	ORCA - Floor Standing Rack, 800x800x47U, front glass single door, blind rear and side panels in 2 sections, load capacity 800 kg Black